



ARREDO
UFFICIO

ACCOGLIENZA

RECEPTION GIADA

- Componenti ----- pag. 366
- Esempi di composizione ----- pag. 367
- Finiture ----- pag. 368

La reception è interamente realizzata in conglomerato ligneo rivestito in melaminico e bordato in ABS con raggio di curvatura mm. 2.

Fianchi, pannelli frontali e laterali: corredati di piedini di livellamento.

Colonna intermedia: in tubolare di acciaio a sezione quadrata mm. 70 x 70 verniciata in colore alluminio gofrato, con piedino regolabile.

Le mensole reception sono composte da un pannello verticale di h. mm. 700 e da uno orizzontale (mensola) di mm. 300 di profondità. Possono essere realizzate in conglomerato ligneo rivestito in melaminico e bordato in ABS, oppure in vetro retrolaccato accoppiato a pannelli di supporto in melaminico.

Spessori: piani, fianchi, pannelli frontali e laterali mm. 25; mensole in melaminico mm. 18; mensole in vetro mm. 5 accoppiato a pannello di supporto in melaminico mm. 18.







PANNELLI FRONTALI
Completi di ferramenta.

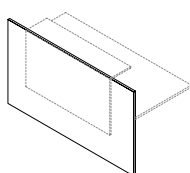

ART.	VARIANTI		DIMENSIONI LxH (mm)
D8401	MD	MK	1200 x 1050
D8403	MD	MK	1400 x 1050
D8405	MD	MK	1600 x 1050
D8407	MD	MK	1800 x 1050

PANNELLI LATERALI
Completi di ferramenta.

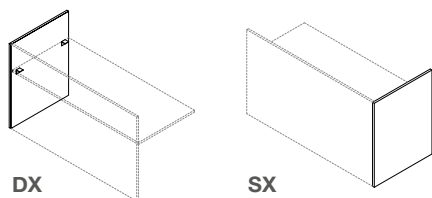

ART.	VARIANTI		DIMENSIONI LxH (mm)	
D8409	MD	MK	825 x 1050	DX
D8411	MD	MK	825 x 1050	SX

PIANI LINEARI
PROFONDITÀ MM 800
Con foro e boccola passacavi. Per art. D8426B si consiglia di abbinare la colonna art. D8462 per un maggior sostegno.

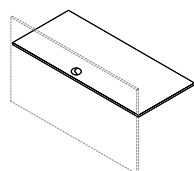

ART.	VARIANTI		DIMENSIONI LxH (mm)
D8420B	MD	MK	1200 x 800
D8422B	MD	MK	1400 x 800
D8424B	MD	MK	1600 x 800
D8426B	MD	MK	1800 x 800

Altezza piano di lavoro mm. 745.

FIANCO INTERMEDIO PER COMPOSIZIONI
Con doppia piastra a "L".



ART.	VARIANTI		DIMENSIONI LxH (mm)
D8460	MD	MK	570 x 720

COLONNA INTERMEDIA PER COMPOSIZIONI
Colore alluminio.



ART.	DIMENSIONI LxH (mm)
D8462	70 x 70 x 720

COPPIA FIANCHI TERMINALI PER RECEPTION

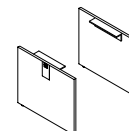

ART.	VARIANTI		DIMENSIONI LxH (mm)
D8464	MD	MK	800 x 720

MODULI ANGOLARI
Completi di piani e staffe.

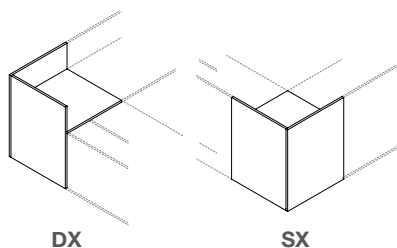

ART.	VARIANTI		DIMENSIONI LxPxH (mm)	
D8415	MDD	MKK	825 x 825 x 1050	DX
D8417	MDD	MKK	825 x 825 x 1050	SX

Altezza piano di lavoro mm. 745.

MENSOLE
Con supporti in metallo.

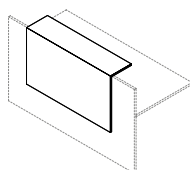

ART.	VARIANTI				DIMENSIONI LxPxH (mm)
D8446	MD	MFN	MK	VD	800 x 300 x 700
D8448	MD	MFN	MK	VD	1200 x 300 x 700



Prodotti forniti
smontati

SINGOLA

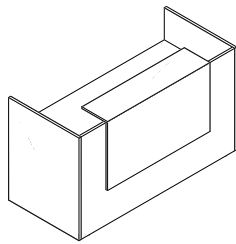

ART.	VARIANTI			DIMENSIONI LxPxH (mm)
D8466	DDK	KKF	KKVD	1650 x 825 x 1050
D8468	DDK	KKF	KKVD	1850 x 825 x 1050

Mensola di mm. 1200.

DOPPIA

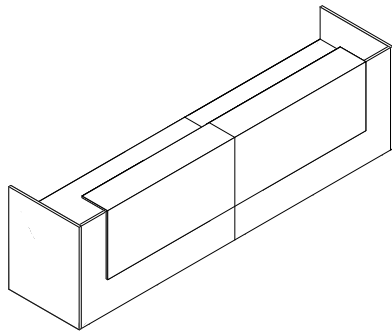

ART.	VARIANTI			DIMENSIONI LxPxH (mm)
D8470	DDK	KKF	KKVD	2850 x 825 x 1050
D8472	DDK	KKF	KKVD	3250 x 825 x 1050

Mensole di mm. 1200.

ANGOLARE

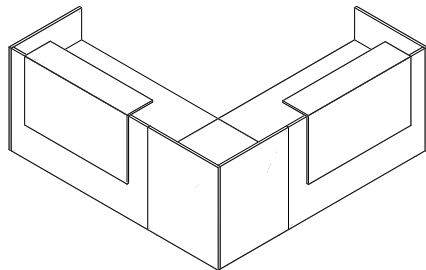

ART.	VARIANTI			DIMENSIONI LxPxH (mm)	
D8474D	DDK	KKF	KKVD	2250 x 2250 x 1050	DX
D8476D	DDK	KKF	KKVD	2450 x 2450 x 1050	DX
D8474S	DDK	KKF	KKVD	2250 x 2250 x 1050	SX
D8476S	DDK	KKF	KKVD	2450 x 2450 x 1050	SX

Mensole di mm. 1200.

La Serie Giada è abbinabile alle Librerie della Serie Funzionale che trovi a pag. 316



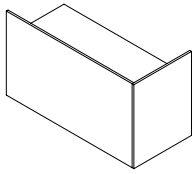

PANNELLI, PIANI E FIANCHI

BIANCO	ACERO
MD	MK

VARIANTI FINITURE

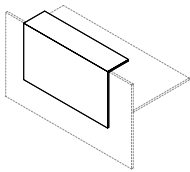

MENSOLE RECEPTION

BIANCO	FANGO	ACERO	VETRO BIANCO
MD	MFN	MK	VD

VARIANTI FINITURE

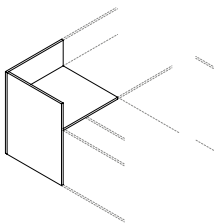

MODULI ANGOLARI

BIANCO	ACERO
MDD	MKK

VARIANTI FINITURE

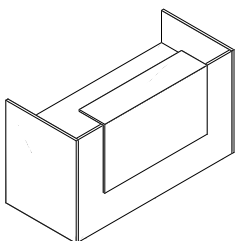

ESEMPI COMPOSITIVI

ACERO	FANGO	VETRO BIANCO
BIANCO	ACERO	ACERO
BIANCO	ACERO	ACERO
DDK	KKF	KKVD

MENSOLE

PIANI

PANNELLI

VARIANTI FINITURE