

# TOP DRILL M1™

Foratura modulare universale • TDM1

La punta modulare TDM1 è destinata ai clienti che cercano un sistema di facile utilizzo in grado di operare su una varietà di materiali con una singola geometria di punta e un corpo utensile con un meccanismo di bloccaggio frontale a cambio rapido.

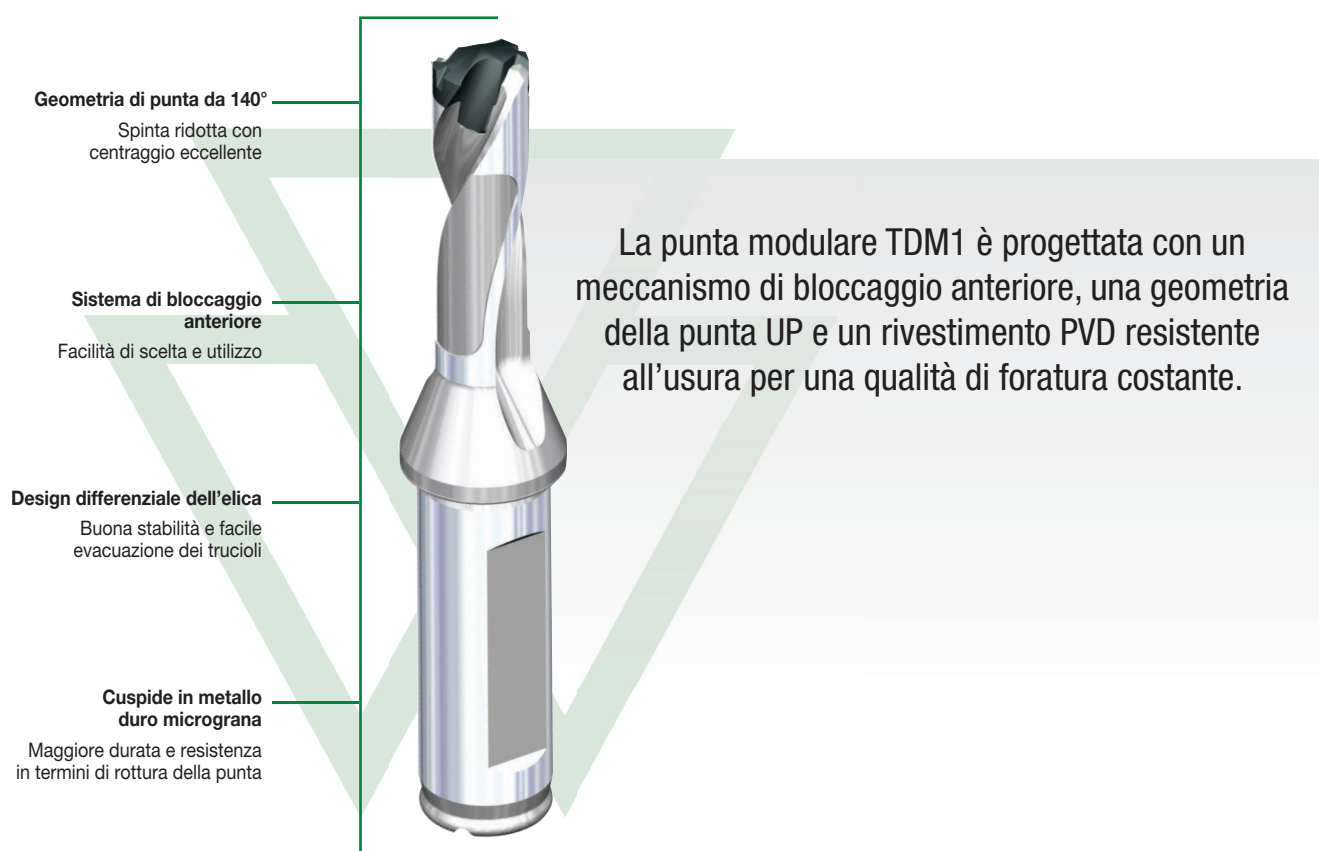

**WU25PD**

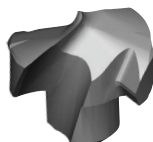

Metallo duro a micrograna,  
multistrato TiAlN per acciaio, acciaio  
inossidabile e ghisa

# VERSATILITÀ MODULARE

## PRODOTTO

TDM1 è una punta a bloccaggio anteriore con geometria universale della punta e qualità adatta per materiali PMK.

## GAMMA DI DIAMETRI

8–25,99mm

## SETTORE



## MATERIALI

### PRIMA SCELTA



### SECONDA SCELTA



## APPLICAZIONI



FORATURA



REFRIGERANTE INTERNO



2 VANI/  
2 MARGINI/  
REFRIGERANTE

## CORPI IN ACCIAIO

SERIE	REFRIGERANTE	RAPPORTO LUNGHEZZA	GAMMA DI DIAMETRI
TDM1	Refrigerante interno	3 x D	7,94–25,99mm
TDM1	Refrigerante interno	5 x D	7,94–25,99mm
TDM1	Refrigerante interno	8 x D	7,94–25,99mm

## Tipo di codolo

Stelo flamgiato e con pianetto

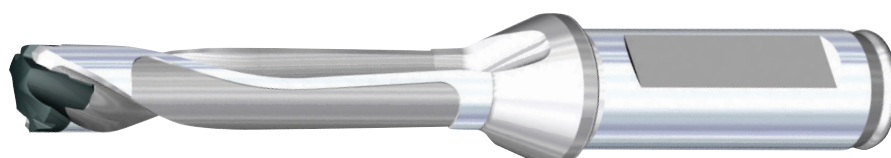
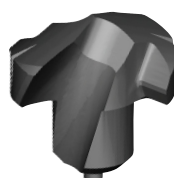

## Inserti TDM1 • Sistema di nomenclatura del catalogo

Ciascuna cifra e lettera del codice nel nostro catalogo indica una specifica caratteristica del relativo prodotto.  
Le seguenti colonne di riferimento e le figure corrispondenti consentono di identificare facilmente le caratteristiche del prodotto.

TDM	2599	UPM	WU25PD
Top Drill Modular	Diametro dell'inserto	Geometria inserto	Qualità
	25,99mm	PK = acciaio e ghisa	WIDIA™; Universale, Applicazione 25 = metallo duro resistente all'usura, rivestimento PVD, Drill/Foratura

## Corpi TDM1 • Sistema di nomenclatura del catalogo

Ciascuna cifra e lettera del codice nel nostro catalogo indica una specifica caratteristica del relativo prodotto.  
Le seguenti colonne di riferimento e le figure corrispondenti consentono di identificare facilmente le caratteristiche del prodotto.

TDM	250	R8	SCF	25M
Top Drill Modular	Diametro del corpo punta	Rapporto L/D	Tipo di codolo	Diametro del codolo
	25mm	8 x D	Steli flangiati con pianetto	25mm

TOP DRILL M1™ • 3 x D • Stelo flangiato • Sistema metrico

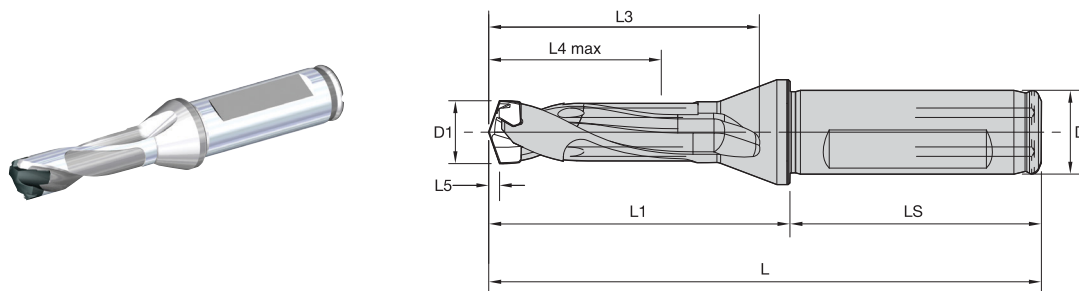

numero d'ordine	codice catalogo	D1	D1 max	D	L	L1	L3	L4 max	L5	LS	SSC
3850904	TDM080R3SCF12M	7,94	8,49	12	86	41	35	26	1,5	45	W10
3850906	TDM085R3SCF12M	8,50	8,99	12	88	43	37	27	1,6	45	W11
3850908	TDM090R3SCF12M	9,00	9,49	12	90	45	39	29	1,7	45	W12
3850910	TDM095R3SCF12M	9,50	9,99	12	92	47	41	30	1,8	45	W13
3850912	TDM100R3SCF16M	10,00	10,49	16	97	49	43	32	1,9	48	W14
3850924	TDM105R3SCF16M	10,50	10,99	16	99	51	45	33	2,0	48	W15
3850926	TDM110R3SCF16M	11,00	11,49	16	101	53	47	35	2,1	48	W16
3850928	TDM115R3SCF16M	11,50	11,99	16	103	55	49	36	2,2	48	W17
3850930	TDM120R3SCF16M	12,00	12,49	16	106	58	52	38	2,3	48	W18
3850932	TDM125R3SCF16M	12,50	12,99	16	108	60	54	39	2,4	48	W19
3850934	TDM130R3SCF16M	13,00	13,49	16	110	62	56	41	2,5	48	W20
3850936	TDM135R3SCF16M	13,50	13,99	16	112	64	58	42	2,6	48	W21
3850938	TDM140R3SCF16M	14,00	14,49	16	114	66	60	44	2,7	48	W22
3850940	TDM145R3SCF16M	14,50	14,99	16	116	68	62	45	2,8	48	W23
3850942	TDM150R3SCF20M	15,00	15,99	20	122	72	66	48	2,8	50	W24
3850944	TDM160R3SCF20M	16,00	16,99	20	126	76	70	51	3,0	50	W25
3850946	TDM170R3SCF20M	17,00	17,99	20	131	81	75	54	3,2	50	W26
3850948	TDM180R3SCF25M	18,00	18,99	25	141	85	79	57	3,4	56	W27
3850950	TDM190R3SCF25M	19,00	19,99	25	144	89	83	60	3,6	56	W28
3850952	TDM200R3SCF25M	20,00	20,99	25	149	93	87	63	3,8	56	W29
3992070	TDM210R3SCF25M	21,00	21,99	25	153	97	91	66	3,7	56	W30
3992071	TDM220R3SCF25M	22,00	22,99	25	158	102	96	69	3,9	56	W31
3992072	TDM230R3SCF25M	23,00	23,99	25	162	106	100	72	4,1	56	W32
3992483	TDM240R3SCF25M	24,00	24,99	25	166	110	104	75	4,2	56	W33
3992484	TDM250R3SCF25M	25,00	25,99	25	170	114	108	78	4,4	56	W34

NOTA: SSC = riferimento sede inserto. Corrispondente all'SSC sugli inserti.

TOP DRILL M1™ • 5 x D • Stelo flangiato • Sistema metrico

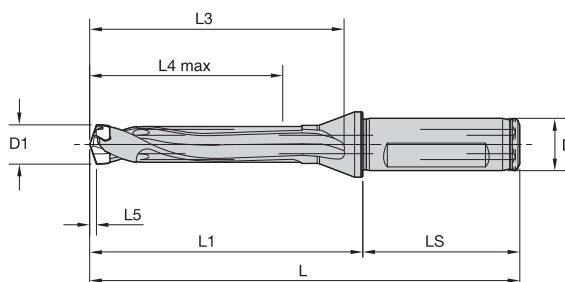

numero d'ordine	codice catalogo	D1	D1 max	D	L	L1	L3	L4 max	L5	LS	SSC
3850905	TDM080R5SCF12M	7,94	8,49	12	104	59	53	43	1,5	45	W10
3850907	TDM085R5SCF12M	8,50	8,99	12	107	62	56	45	1,6	45	W11
3850909	TDM090R5SCF12M	9,00	9,49	12	110	65	59	48	1,7	45	W12
3850911	TDM095R5SCF12M	9,50	9,99	12	114	69	63	50	1,8	45	W13
3850923	TDM100R5SCF16M	10,00	10,49	16	120	72	66	53	1,9	48	W14
3850925	TDM105R5SCF16M	10,50	10,99	16	123	75	69	55	2,0	48	W15
3850927	TDM110R5SCF16M	11,00	11,49	16	126	78	72	58	2,1	48	W16
3850929	TDM115R5SCF16M	11,50	11,99	16	129	81	75	60	2,2	48	W17
3850931	TDM120R5SCF16M	12,00	12,49	16	132	84	78	63	2,3	48	W18
3850933	TDM125R5SCF16M	12,50	12,99	16	135	87	81	65	2,4	48	W19
3850935	TDM130R5SCF16M	13,00	13,49	16	138	90	84	68	2,5	48	W20
3850937	TDM135R5SCF16M	13,50	13,99	16	142	94	88	70	2,6	48	W21
3850939	TDM140R5SCF16M	14,00	14,49	16	145	97	91	73	2,7	48	W22
3850941	TDM145R5SCF16M	14,50	14,99	16	148	100	94	75	2,8	48	W23
3850943	TDM150R5SCF20M	15,00	15,99	20	156	106	100	80	2,8	50	W24
3850945	TDM160R5SCF20M	16,00	16,99	20	162	112	106	85	3,0	50	W25
3850947	TDM170R5SCF20M	17,00	17,99	20	169	119	113	90	3,2	50	W26
3850949	TDM180R5SCF25M	18,00	18,99	25	181	125	119	95	3,4	56	W27
3850951	TDM190R5SCF25M	19,00	19,99	25	187	131	125	100	3,6	56	W28
3850953	TDM200R5SCF25M	20,00	20,99	25	193	137	131	105	3,8	56	W29
3992485	TDM210R5SCF25M	21,00	21,99	25	200	144	138	110	3,7	56	W30
3992486	TDM220R5SCF25M	22,00	22,99	25	206	150	144	115	3,9	56	W31
3992487	TDM230R5SCF25M	23,00	23,99	25	212	156	150	120	4,1	56	W32
3992488	TDM240R5SCF25M	24,00	24,99	25	218	162	156	125	4,2	56	W33
3992489	TDM250R5SCF25M	25,00	25,99	25	225	169	163	130	4,4	56	W34

NOTA: SSC = riferimento sede. Corrispondente al SSC sugli inserti.

FRESATURA A INSERTI

FRESATURA IN METALLO DURO

FORATURA

MASCHIATURA

TORNITURA

TOP DRILL M1™ • 8 x D • Stelo flangiato • Sistema metrico

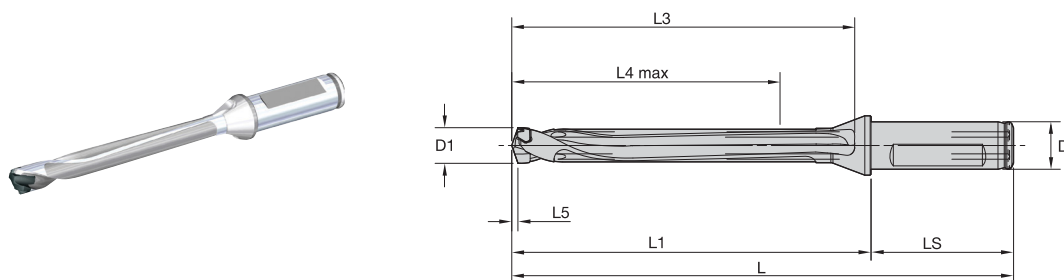

numero d'ordine	codice catalogo	D1	D1 max	D	L	L1	L3	L4 max	L5	LS	SSC
3992141	TDM080R8SCF12M	7,94	8,49	12	129	84	79	68	1,4	45	W10
3992142	TDM085R8SCF12M	8,50	8,99	12	134	89	83	72	1,5	45	W11
3992213	TDM090R8SCF12M	9,00	9,49	12	138	93	88	76	1,6	45	W12
3992214	TDM095R8SCF12M	9,50	9,99	12	144	99	93	80	1,7	45	W13
3992215	TDM100R8SCF16M	10,00	10,49	16	151	103	98	84	1,8	48	W14
3992216	TDM105R8SCF16M	10,50	10,99	16	156	108	102	88	1,9	48	W15
3992217	TDM110R8SCF16M	11,00	11,49	16	160	112	107	92	2,0	48	W16
3992218	TDM115R8SCF16M	11,50	11,99	16	165	117	111	96	2,1	48	W17
3992219	TDM120R8SCF16M	12,00	12,49	16	169	121	116	100	2,1	48	W18
3992220	TDM125R8SCF16M	12,50	12,99	16	174	126	120	104	2,2	48	W19
3992221	TDM130R8SCF16M	13,00	13,49	16	178	130	125	108	2,3	48	W20
3992222	TDM135R8SCF16M	13,50	13,99	16	184	136	130	112	2,4	48	W21
3992223	TDM140R8SCF16M	14,00	14,49	16	188	140	135	116	2,5	48	W22
3992224	TDM145R8SCF16M	14,50	14,99	16	193	145	139	120	2,6	48	W23
3992225	TDM150R8SCF20M	15,00	15,99	20	204	154	148	128	2,7	50	W24
3992226	TDM160R8SCF20M	16,00	16,99	20	213	163	157	136	2,8	50	W25
3992227	TDM170R8SCF20M	17,00	17,99	20	223	173	167	144	3,0	50	W26
3992228	TDM180R8SCF25M	18,00	18,99	25	238	182	176	152	2,9	56	W27
3992229	TDM190R8SCF25M	19,00	19,99	25	247	191	185	160	3,4	56	W28
3992230	TDM200R8SCF25M	20,00	20,99	25	256	200	194	168	3,6	56	W29
3992231	TDM210R8SCF25M	21,00	21,99	25	266	210	204	176	3,7	56	W30
3992232	TDM220R8SCF25M	22,00	22,99	25	275	219	213	184	3,9	56	W31
3992233	TDM230R8SCF25M	23,00	23,99	25	284	228	222	192	4,1	56	W32
3992234	TDM240R8SCF25M	24,00	24,99	25	293	237	231	200	4,2	56	W33
3992235	TDM250R8SCF25M	25,00	25,99	25	303	247	241	208	4,4	56	W34

NOTA: SSC = riferimento sede. Corrispondente al SSC sugli inserti.

FRESATURA A INSERTI

FRESATURA IN METALLO DURO

FORATURA

MASCHIATURA

TORNITURA

TOP DRILL M1™ • Inserti • UP

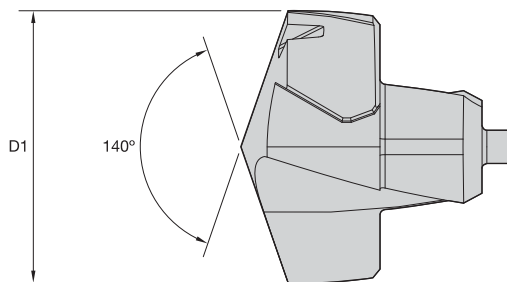
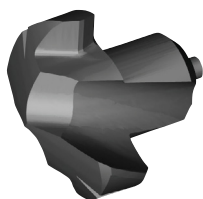

P	●
M	○
K	●
N	○
S	○
H	○

● prima scelta  
○ scelta alternativa

grado WU25PD  
TiAIN

mm#	Codice	D1	SSC
3850959	TDM0794UPM	7,94	W10
3848984	TDM0800UPM	8,00	W10
3848985	TDM0810UPM	8,10	W10
3850960	TDM0816UPM	8,16	W10
3850961	TDM0820UPM	8,20	W10
3848986	TDM0830UPM	8,30	W10
3850962	TDM0833UPM	8,33	W10
3848987	TDM0840UPM	8,40	W10
3850963	TDM0843UPM	8,43	W10
3848988	TDM0850UPM	8,50	W11
3848989	TDM0860UPM	8,60	W11
3850964	TDM0861UPM	8,61	W11
3848990	TDM0870UPM	8,70	W11
3850965	TDM0873UPM	8,73	W11
3848991	TDM0880UPM	8,80	W11
3850966	TDM0884UPM	8,84	W11
3848992	TDM0890UPM	8,90	W11
3849043	TDM0900UPM	9,00	W12
3850967	TDM0909UPM	9,09	W12
3849044	TDM0910UPM	9,10	W12
3850968	TDM0913UPM	9,13	W12
3849045	TDM0920UPM	9,20	W12
3849046	TDM0930UPM	9,30	W12
3850969	TDM0935UPM	9,35	W12
3849047	TDM0940UPM	9,40	W12
3849048	TDM0950UPM	9,50	W13
3850970	TDM0953UPM	9,53	W13
3850971	TDM0956UPM	9,56	W13
3850972	TDM0958UPM	9,58	W13
3849049	TDM0960UPM	9,60	W13
3850973	TDM0970UPM	9,70	W13
3850974	TDM0980UPM	9,80	W13
3849050	TDM0990UPM	9,90	W13
3850975	TDM0992UPM	9,92	W13
3849051	TDM1000UPM	10,00	W14
3850976	TDM1002UPM	10,02	W14
3850977	TDM1008UPM	10,08	W14
3849052	TDM1010UPM	10,10	W14
3849053	TDM1020UPM	10,20	W14
3850978	TDM1026UPM	10,26	W14
3849054	TDM1030UPM	10,30	W14
3850979	TDM1032UPM	10,32	W14
3849055	TDM1040UPM	10,40	W14
3850980	TDM1049UPM	10,49	W14
3849056	TDM1050UPM	10,50	W15
3849057	TDM1060UPM	10,60	W15
3849058	TDM1070UPM	10,70	W15
3850981	TDM1072UPM	10,72	W15
3849059	TDM1080UPM	10,80	W15
3849060	TDM1090UPM	10,90	W15
3849061	TDM1100UPM	11,00	W16
3849062	TDM1110UPM	11,10	W16

TOP DRILL M1™ • Inserti • UP

(continua)

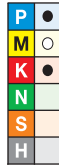
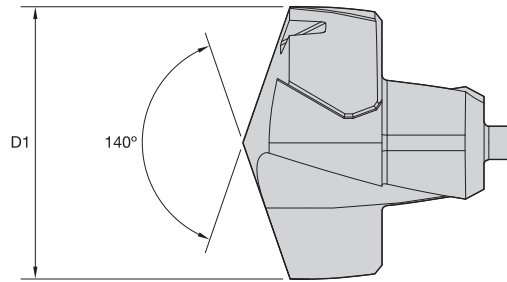
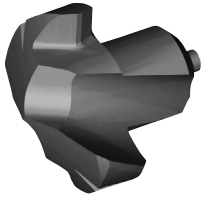

- prima scelta
- scelta alternativa

grado WU25PD TiAlN		D1	SSC
mm#	Codice		
3850982	TDM1111UPM	11,11	W16
3849063	TDM1120UPM	11,20	W16
3849064	TDM1130UPM	11,30	W16
3849065	TDM1140UPM	11,40	W16
3849066	TDM1150UPM	11,50	W17
3850983	TDM1151UPM	11,51	W17
3849067	TDM1160UPM	11,60	W17
3850984	TDM1161UPM	11,61	W17
3849068	TDM1170UPM	11,70	W17
3849069	TDM1180UPM	11,80	W17
3849070	TDM1190UPM	11,90	W17
3850985	TDM1191UPM	11,91	W17
3849071	TDM1200UPM	12,00	W18
3849072	TDM1210UPM	12,10	W18
3849073	TDM1220UPM	12,20	W18
3850986	TDM1230UPM	12,30	W18
3849074	TDM1240UPM	12,40	W18
3850987	TDM1247UPM	12,47	W18
3849075	TDM1250UPM	12,50	W19
3849076	TDM1260UPM	12,60	W19
3850988	TDM1270UPM	12,70	W19
3849077	TDM1280UPM	12,80	W19
3850989	TDM1290UPM	12,90	W19
3849078	TDM1300UPM	13,00	W20
3850990	TDM1310UPM	13,10	W20
3849079	TDM1320UPM	13,20	W20
3849080	TDM1330UPM	13,30	W20
3849081	TDM1340UPM	13,40	W20
3850991	TDM1349UPM	13,49	W20
3849082	TDM1350UPM	13,50	W21
3849083	TDM1360UPM	13,60	W21
3849084	TDM1370UPM	13,70	W21
3849085	TDM1380UPM	13,80	W21
3850992	TDM1389UPM	13,89	W21
3850993	TDM1390UPM	13,90	W21
3849086	TDM1400UPM	14,00	W22
3849087	TDM1410UPM	14,10	W22
3849088	TDM1420UPM	14,20	W22
3850994	TDM1429UPM	14,29	W22
3849089	TDM1430UPM	14,30	W22
3849090	TDM1440UPM	14,40	W22
3849091	TDM1450UPM	14,50	W23
3849092	TDM1460UPM	14,60	W23
3850995	TDM1467UPM	14,67	W23
3850996	TDM1468UPM	14,68	W23
3849093	TDM1470UPM	14,70	W23
3849094	TDM1480UPM	14,80	W23
3849095	TDM1490UPM	14,90	W23
3849096	TDM1500UPM	15,00	W24
3850997	TDM1508UPM	15,08	W24
3849097	TDM1510UPM	15,10	W24
3849098	TDM1520UPM	15,20	W24



TOP DRILL M1™ • Inserti • UP

(continua)

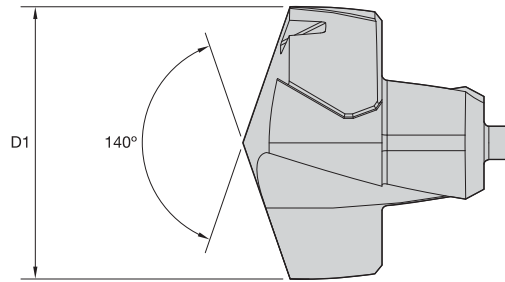
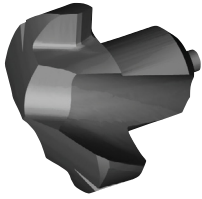

P	●
M	○
K	●
N	○
S	○
H	○

● prima scelta  
○ scelta alternativa

grado WU25PD  
TiAIN

mm#	Codice	D1	SSC
3849099	TDM1530UPM	15,30	W24
3849100	TDM1540UPM	15,40	W24
3850998	TDM1548UPM	15,48	W24
3849101	TDM1550UPM	15,50	W24
3849102	TDM1560UPM	15,60	W24
3849103	TDM1570UPM	15,70	W24
3849104	TDM1580UPM	15,80	W24
3850999	TDM1588UPM	15,88	W24
3849105	TDM1600UPM	16,00	W25
3851000	TDM1603UPM	16,03	W25
3851001	TDM1608UPM	16,08	W25
3849106	TDM1610UPM	16,10	W25
4010625	TDM1618UPM	16,18	W25
3849107	TDM1620UPM	16,20	W25
3851002	TDM1627UPM	16,27	W25
3849108	TDM1630UPM	16,30	W25
3849109	TDM1640UPM	16,40	W25
3849110	TDM1650UPM	16,50	W25
3849111	TDM1660UPM	16,60	W25
3851003	TDM1667UPM	16,67	W25
3849112	TDM1670UPM	16,70	W25
3849113	TDM1680UPM	16,80	W25
3851004	TDM1687UPM	16,87	W25
3849114	TDM1690UPM	16,90	W25
3849119	TDM1700UPM	17,00	W26
3851005	TDM1707UPM	17,07	W26
3849120	TDM1710UPM	17,10	W26
3849121	TDM1720UPM	17,20	W26
3849122	TDM1730UPM	17,30	W26
3849193	TDM1740UPM	17,40	W26
3851006	TDM1746UPM	17,46	W26
3849194	TDM1750UPM	17,50	W26
3849195	TDM1760UPM	17,60	W26
3849196	TDM1770UPM	17,70	W26
3849197	TDM1780UPM	17,80	W26
3851007	TDM1786UPM	17,86	W26
3849198	TDM1790UPM	17,90	W26
3849199	TDM1800UPM	18,00	W27
3849200	TDM1810UPM	18,10	W27
3849201	TDM1820UPM	18,20	W27
3851008	TDM1826UPM	18,26	W27
3849202	TDM1830UPM	18,30	W27
3849203	TDM1840UPM	18,40	W27
3849204	TDM1850UPM	18,50	W27
3849205	TDM1860UPM	18,60	W27
3851009	TDM1865UPM	18,65	W27
3849206	TDM1870UPM	18,70	W27
3849207	TDM1880UPM	18,80	W27
3849208	TDM1890UPM	18,90	W27
3849209	TDM1900UPM	19,00	W28
3851010	TDM1905UPM	19,05	W28
3849210	TDM1910UPM	19,10	W28

TOP DRILL M1™ • Inserti • UP

(continua)

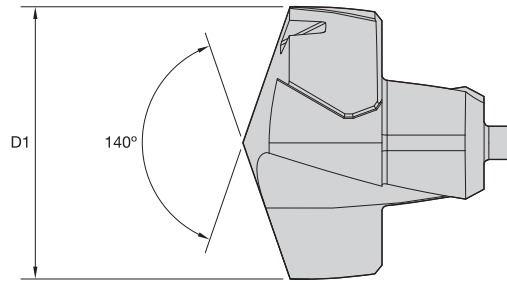
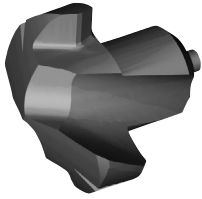

● prima scelta  
○ scelta alternativa

grado WU25PD  
TiAIN

mm#	Codice	D1	SSC
3849211	TDM1920UPM	19,20	W28
3851011	TDM1923UPM	19,23	W28
3851012	TDM1925UPM	19,25	W28
3851013	TDM1928UPM	19,28	W28
3849212	TDM1930UPM	19,30	W28
3851014	TDM1935UPM	19,35	W28
3849213	TDM1940UPM	19,40	W28
3851015	TDM1945UPM	19,45	W28
3849214	TDM1950UPM	19,50	W28
3849215	TDM1960UPM	19,60	W28
3849216	TDM1970UPM	19,70	W28
3849217	TDM1980UPM	19,80	W28
3851016	TDM1984UPM	19,84	W28
3849218	TDM1990UPM	19,90	W28
3849219	TDM2000UPM	20,00	W29
3849220	TDM2010UPM	20,10	W29
3849221	TDM2020UPM	20,20	W29
3851017	TDM2024UPM	20,24	W29
3849222	TDM2030UPM	20,30	W29
3849223	TDM2040UPM	20,40	W29
3849224	TDM2050UPM	20,50	W29
3849225	TDM2060UPM	20,60	W29
3851018	TDM2064UPM	20,64	W29
3849226	TDM2070UPM	20,70	W29
3849227	TDM2080UPM	20,80	W29
3849228	TDM2090UPM	20,90	W29
3849229	TDM2099UPM	20,99	W29
4003225	TDM2100UPM	21,00	W30
4003203	TDM2144UPM	21,44	W30
3969291	TDM2150UPM	21,50	W30
4003226	TDM2200UPM	22,00	W31
4003204	TDM2223UPM	22,23	W31
4003205	TDM2245UPM	22,45	W31
4003227	TDM2250UPM	22,50	W31
4003228	TDM2300UPM	23,00	W32
4003229	TDM2350UPM	23,50	W32
4003206	TDM2381UPM	23,81	W32
4003230	TDM2400UPM	24,00	W33
4003231	TDM2450UPM	24,50	W33
4003207	TDM2461UPM	24,61	W33
4003232	TDM2500UPM	25,00	W34
4003208	TDM2540UPM	25,40	W34
4002444	TDM2550UPM	25,50	W34
4003209	TDM2568UPM	25,68	W34
4003210	TDM2581UPM	25,81	W34
3992013	TDM2599UPM	25,99	W34

Dati tecnici • UP • WU25PD™ • Sistema metrico

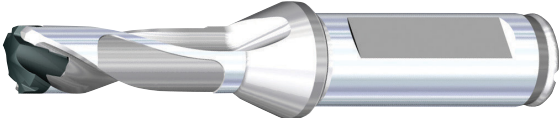
												
		Velocità di taglio – vc			Avanzamenti consigliati							
		Intervallo – m/min										
Gruppo materiali		min	Valore iniziale	max	Diametro utensile (mm)	8,0	10,0	12,0	14,0	16,0	20,0	25,0
	1	90	125	170	mm/giro	0,11–0,20	0,13–0,25	0,14–0,31	0,17–0,39	0,19–0,45	0,25–0,48	0,30–0,52
P	2	105	140	180	mm/giro	0,11–0,28	0,12–0,35	0,16–0,37	0,21–0,46	0,23–0,46	0,28–0,50	0,30–0,52
	3	50	75	100	mm/giro	0,11–0,28	0,12–0,35	0,16–0,37	0,21–0,46	0,23–0,46	0,28–0,50	0,30–0,52
	4	50	75	100	mm/giro	0,11–0,28	0,12–0,35	0,16–0,37	0,17–0,36	0,19–0,45	0,22–0,48	0,25–0,50
	5	50	65	80	mm/giro	0,10–0,20	0,10–0,23	0,10–0,25	0,14–0,29	0,16–0,32	0,18–0,36	0,22–0,42
	6	50	65	80	mm/giro	0,10–0,20	0,10–0,23	0,10–0,25	0,14–0,29	0,16–0,32	0,18–0,36	0,22–0,42
	6	50	65	80	mm/giro	0,10–0,20	0,10–0,23	0,10–0,25	0,14–0,29	0,16–0,32	0,18–0,36	0,22–0,42
M	1	40	80	110	mm/giro	0,06–0,22	0,08–0,23	0,09–0,24	0,10–0,25	0,11–0,26	0,13–0,28	0,13–0,32
	2	35	55	75	mm/giro	0,06–0,22	0,08–0,23	0,09–0,24	0,10–0,25	0,11–0,26	0,13–0,28	0,13–0,32
	3	20	35	50	mm/giro	0,06–0,22	0,08–0,23	0,09–0,24	0,10–0,25	0,11–0,26	0,13–0,28	0,13–0,32
K	1	60	95	170	mm/giro	0,15–0,29	0,16–0,32	0,17–0,35	0,21–0,42	0,25–0,48	0,28–0,52	0,32–0,56
	2	60	75	90	mm/giro	0,15–0,29	0,16–0,30	0,17–0,33	0,21–0,41	0,25–0,48	0,28–0,52	0,32–0,56
	3	40	65	90	mm/giro	0,16–0,30	0,17–0,33	0,18–0,36	0,20–0,41	0,21–0,44	0,23–0,48	0,25–0,50

NOTA: Refrigerante interno consigliato solo per applicazioni superiori a 3 x D.

FRESATURA A INSERTI

FRESATURA IN METALLO DURO

FORATURA

MASCHIATURA

TORNITURA

Dati tecnici • Victory™ TOP DRILL M1™

Istruzioni per il montaggio degli inserti



1) Fissare il portautensili sul mandrino. Per cambiare l'inserto, fissare il mandrino in macchina o sul dispositivo di preassettaggio.



2) Rimuovere la polvere utilizzando un getto d'aria.



3) Inserire l'inserto nel portautensili. (Utilizzare i guanti per proteggere le mani).

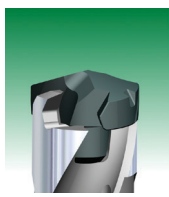

4) Ruotare leggermente in senso orario. (Utilizzare i guanti per proteggere le mani).



5) Impostare la chiave in maniera corretta.\*



6) Verificare che la chiave corrisponda alla relativa scanalatura sull'inserto.



7) Ruotare lentamente la chiave in senso orario.



8) Completo.

Istruzioni per lo smontaggio degli inserti

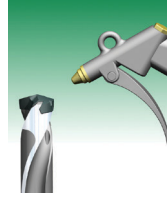

1) Rimuovere la polvere utilizzando un getto d'aria.



2) Impostare la chiave in maniera corretta.\*



3) Inserire la chiave nella relativa scanalatura dell'inserto.



4) Ruotare la chiave in senso antiorario.

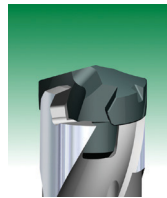

5) Una volta sbloccato, è possibile ruotare l'inserto manualmente. (Utilizzare i guanti per proteggere le mani).



6) Rimuovere l'inserto. (Utilizzare i guanti per proteggere le mani).

\*Per ordinare la chiave di bloccaggio/sbloccaggio inserto TDM1 fare riferimento al numero d'ordine 3861623 oppure alla sua descrizione 170.315

FRESATURA A INSERTI

FRESATURA IN METALLO DURO

FORATURA

MASCHIATURA

TORNITURA

## Dati tecnici • Victory™ TOP DRILL M1™

### Avvertenze

#### Refrigerante

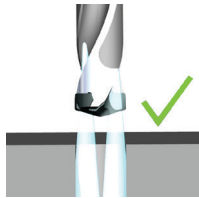

1) Si raccomanda l'utilizzo di un flusso di refrigerante interno.

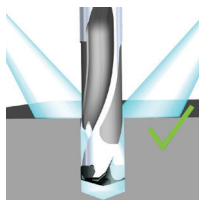

2) In caso di utilizzo di un flusso di refrigerante esterno, la profondità di taglio non deve essere superiore a  $3 \times D$ .

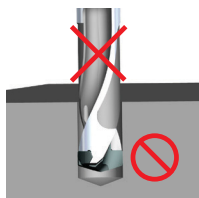

3) Il taglio a secco non è raccomandato. Applicabilità limitata in materiali in ghisa, MQL fortemente raccomandato.

#### Precauzioni per l'uso

##### Deviazione

1) Per i torni

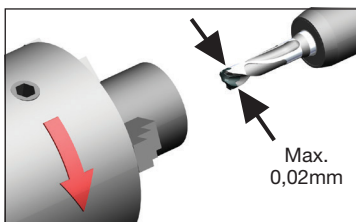

Impostare una deviazione fra pezzo e punta inferiore a 0,02mm.

2) Per i centri di lavoro

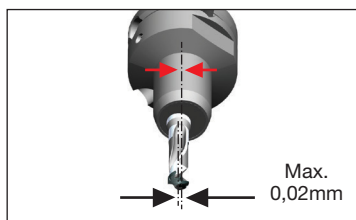

Non utilizzare adattatori con superficie di attacco danneggiata. La deviazione dal centro dell'asse non deve superare 0,02mm.

Consigli per l'applicazione	Forma del pezzo
Consigliato per foratura a fondo piatto	
Consigliato per foratura a pacco	
Non raccomandato per foratura su superfici inclinate $>3^\circ$	
Non raccomandato per fori semicircolari	
Non raccomandato per allargare fori	
Non raccomandato su superficie concava	
Non raccomandato per foratura di tubi	
Foro di fusione Non raccomandato	